

3.2 DIN Monitoring Relays

DIN Monitoring Relays

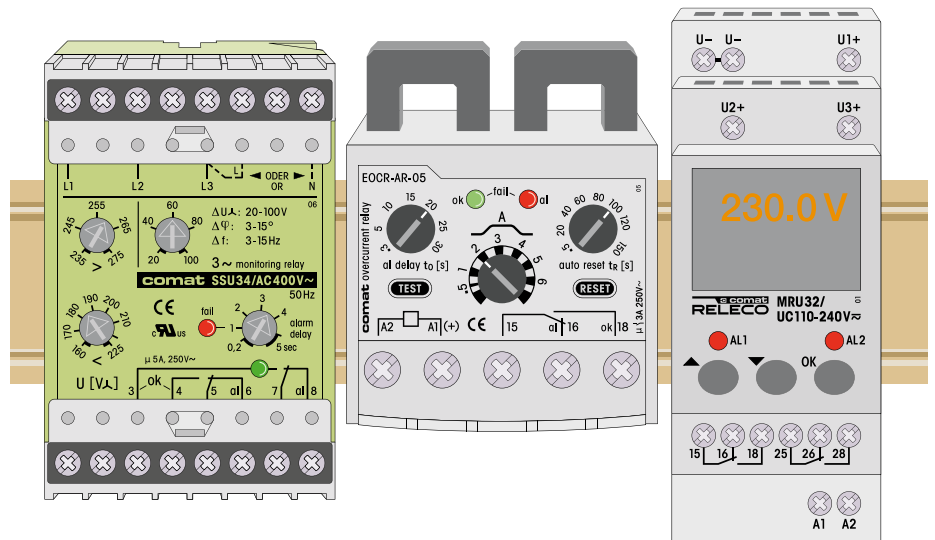

Application	Types	Monitoring	Monitoring ratings	Output contacts	Design
Voltage monitoring, AC 15 ... 60 Hz / DC single phase	MRU11		0 ... AC 480 V / DC 700 V	1 CO	35 mm
Voltage monitoring, AC 15 ... 60 Hz / DC three phase	MRU32		0 ... AC 480 V / DC 700 V	2 CO	35 mm
Current monitoring, AC 15 ... 60 Hz / DC single phase	MRI11		0 ... 5 A	1 CO	35 mm
Current monitoring, AC 15 ... 60 Hz / DC three phase	MRI32		0 ... 5 A	2 CO	35 mm
Multifunction monitoring, AC 15 ... 60 Hz / DC single phase	MRM11	 	U, I, P, f, cosφ	1 CO	35 mm
Multifunction monitoring, AC 15 ... 60 Hz / DC three phase	MRM32	 	U, I, P, f, cosφ	2 CO	35 mm
AC Voltage monitoring, AC 50 ... 60 Hz	MV53		AC 115 V, AC 230 V	1 CO	22.5 mm
Over-current monitoring, 48 ... 62 Hz	EOCR		0.5 ... 6 A / 3 ... 30 A / 5 ... 60 A	1 CO	54 mm
Under-current monitoring, 48 ... 62 Hz	EUCR		0.5 ... 6 A / 3 ... 30 A / 5 ... 60 A	1 CO	54 mm
Mains monitoring relay, 50 Hz	SSU34		100 V, 400 V, 500 V	2 CO	50 mm
Mains monitoring relay, 60 Hz	SSU36		208 V, 460 V, 480 V	2 CO	50 mm
Isolation monitoring, DC networks	ESU-D2		1 ... 50 kΩ	1 CO / 1 CO+NO	50 mm

Type: MRU11/...V

Voltage monitoring relay with over- and under voltage thresholds up to 700 V.
 Alarm delay setting. Alarm LED. Display for voltmeter function, alarm signal and interactive parameter setting.
 1 change-over alarm contact 5 A 250 V. Comfortable parameter setting.

Monitoring function

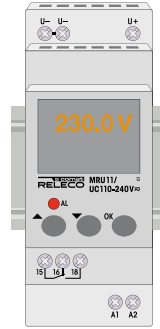
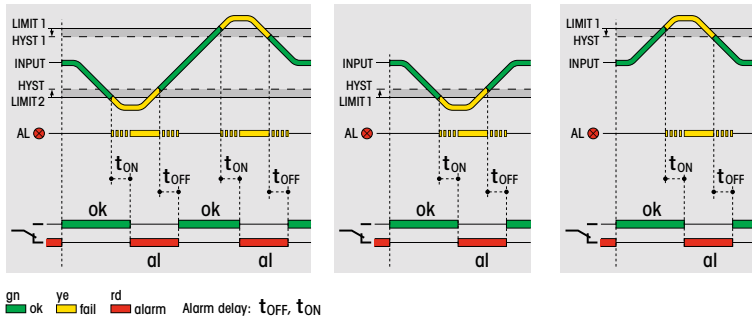

Connection diagram

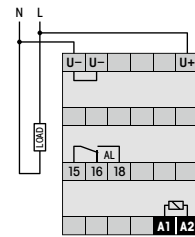

Measuring circuit data

Over/under voltage setting ranges AC / DC	0 ... 480 V / 0 ... 700 V
Frequency	DC, AC 16 ... 100 Hz
Resolution	100 mV
Accuracy	2 % ± 1 digit
Input resistance	1 MΩ

Time data

Alarm delay setting time	0.1 ... 999.9 s
Reset time setting range	0.1 ... 999.9 s
Voltage failure buffering	ca. 30 ms

Contacts

Type / Material	1 CO / AgNi 0.15
Rated operational current	6 A
Max. inrush current	15 A
Max. switching voltage	250 V
Max. AC load AC-1 (Fig.1)	1250 VA
Max. DC load DC-1, 24 V / 220 V (Fig.2)	120 W / 25 V
Recommended min. contact load	10 mA / 10 V

Power supply

	UC12-48V	UC110-240V
Nominal voltage AC/DC	12 ... 48 V	110 ... 240 V
Operating voltage range	9.6 ... 57.6 V	88 ... 288 V
AC frequency	16 ... 63 Hz	16 ... 63 Hz
Power consumption	2 W / 4 VA	2 W / 4 VA

Insulation

Test voltage open - contact	1 kVrms 1 minute
Test voltage measuring input - contacts	4 kVrms 1 minute
Test voltage measuring input - power supply	4 kVrms 1 minute

General specifications

Ambient temperature storage /operation	-40 ... +85 °C / -25 ... +60 °C
Mechanical life of contacts	30 x 10 ⁶ operations
Conductor cross section	Stranded wire 2.5 mm ² , 2 x 1.5 mm ²
Ingress protection degree	IP20, (electronics: IP40)
Max. screw torque	0.4 Nm
Housing material	Lexan EXL 9330
Weight	130 g

Standard types

AC/DC 12-48 V, 15...60 Hz
 AC/DC 110-240 V, 15...60 Hz

MRU11/UC12-48V
 MRU11/UC110-240V

Fig.1 AC voltage endurance

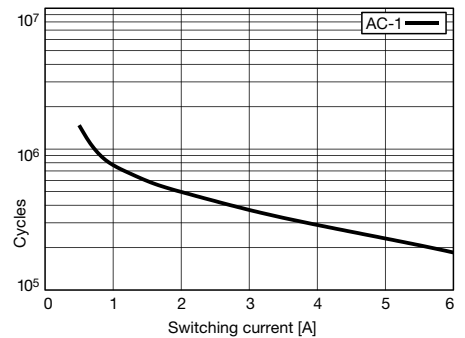
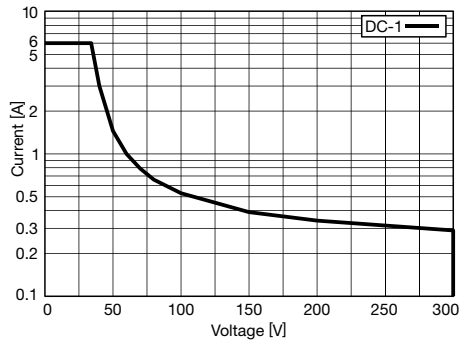
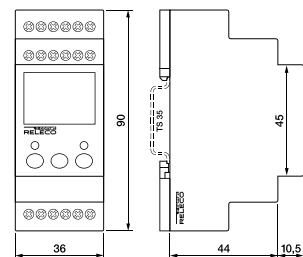

Fig. 2 DC load limit curve



Dimensions [mm]



Technical approvals, conformities



Type: MRU32/...V

Voltage monitoring relay with over- and under voltage thresholds up to 700 V. Alarm delay setting. Alarm LED. Display for voltmeter function, alarm signal and interactive parameter setting. 2 change-over alarm contacts 5 A 250 V. Comfortable parameter setting.

Monitoring function

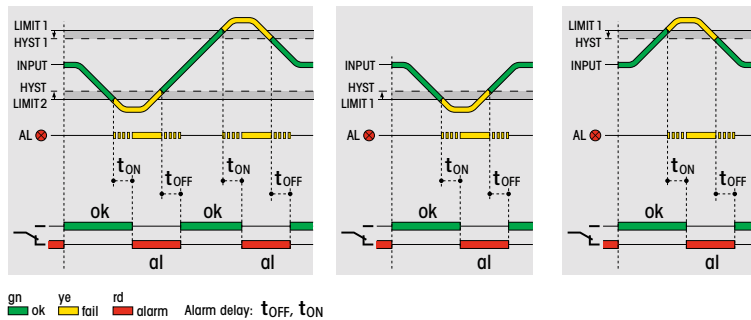

Measuring circuit data

Over/under voltage setting ranges AC / DC	0 ... 480 V / 0 ... 700 V
Frequency	DC, AC 16 ... 100 Hz
Resolution	100 mV
Accuracy	2 % ±1 digit
Input resistance	1 MΩ

Time data

Alarm delay setting time	0.1 ... 999.9 s
Reset time setting range	0.1 ... 999.9 s
Voltage failure buffering	ca. 30 ms

Contacts

Type / Material	2 CO / AgNi 0.15
Rated operational current	6 A
Max. inrush current	15 A
Max. switching voltage	250 V
Max. AC load AC-1 (Fig.1)	1250 VA
Max. DC load DC-1, 24 V / 220 V (Fig.2)	120 W / 25 W
Recommended min. contact load	10 mA / 10 V

Power supply

	UC12-48V	UC110-240V
Nominal voltage AC/DC	12 ... 48 V	110 ... 240 V
Operating voltage range	9.6 ... 57.6 V	88 ... 288 V
AC frequency	16 ... 63 Hz	16 ... 63 Hz
Power consumption	2 W / 4 VA	2 W / 4 VA

Insulation

Test voltage open - contact	1 kVrms 1 minute
Test voltage between poles	2.5 kVrms 1 minute
Test voltage measuring input - contacts	4 kVrms 1 minute
Test voltage measuring input - power supply	4 kVrms 1 minute

General specifications

Ambient temperature storage /operation	-40 ... +85 °C / -25 ... +60 °C
Mechanical life of contacts	30 x 10 ⁶ operations
Conductor cross section	Stranded wire 2.5 mm ² , 2 x 1.5 mm ²
Ingress protection degree	IP20, (electronics: IP40)
Max. screw torque	0.4 Nm
Housing material	Lexan EXL 9330
Weight	130 g

Standard types

AC/DC 12-48 V, 15...60 Hz	MRU32/UC12-48V
AC/DC 110-240 V, 15...60 Hz	MRU32/UC110-240V

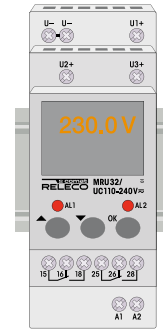

Connection diagram

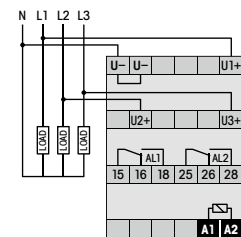

Fig.1 AC voltage endurance

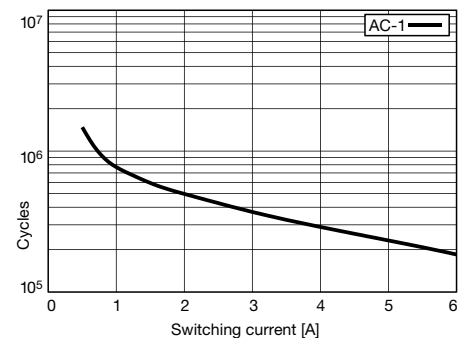
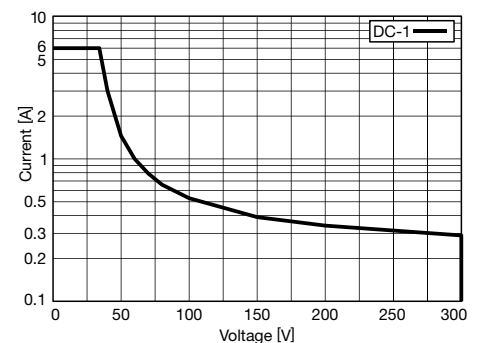
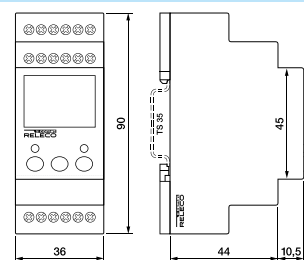

Fig. 2 DC load limit curve



Dimensions [mm]



Technical approvals, conformities



Type: MRI11/...V

Current monitoring relay with over- and under voltage thresholds up to 5 A.
 Alarm delay setting. Alarm LED. Display for voltmeter function, alarm signal
 and interactive parameter setting.

1 change-over alarm contact 5 A 250 V. Comfortable parameter setting.

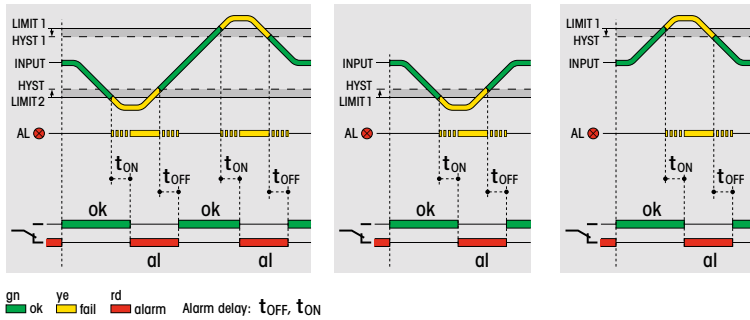
Monitoring function

Measuring circuit data

Over/under current setting ranges AC / DC	0 ... 5 A
Frequency	DC, AC 16 ... 100 Hz
Resolution	1 mA
Accuracy	2 % ± 1 digit
Input resistance	5 MΩ

Time data

Alarm delay setting time	0.1 ... 999.9 s
Reset time setting range	0.1 ... 999.9 s
Voltage failure buffering	ca. 30 ms

Contacts

Type / Material	1 CO / AgNi 0.15	
Rated operational current	6 A	
Max. inrush current	15 A	
Max. switching voltage	250 V	
Max. AC load AC-1 (Fig.1)	1250 VA	
Max. DC load DC-1, 24 V / 220 V (Fig.2)	120 W / 25 V	
Recommended min. contact load	10 mA / 10 V	

Power supply

	UC12-48V	UC110-240V
Nominal voltage AC/DC	12 ... 48 V	110 ... 240 V
Operating voltage range	9.6 ... 57.6 V	88 ... 288 V
AC frequency	16 ... 63 Hz	16 ... 63 Hz
Power consumption	2 W / 4 VA	2 W / 4 VA

Insulation

Test voltage open - contact	1 kVrms 1 minute
Test voltage measuring input - contacts	4 kVrms 1 minute
Test voltage measuring input - power supply	4 kVrms 1 minute

General specifications

Ambient temperature storage /operation	-40 ... +85 °C / -25 ... +60 °C
Mechanical life of contacts	30 x 10 ⁶ operations
Conductor cross section	Stranded wire 2.5 mm ² , 2 x 1.5 mm ²
Ingress protection degree	IP20, (electronics: IP40)
Max. screw torque	0.4 Nm
Housing material	Lexan EXL 9330
Weight	130 g

Standard types

AC/DC 12-48 V, 15...60 Hz
 AC/DC 110-240 V, 15...60 Hz

MRI11/UC12-48V
 MRI11/UC110-240V

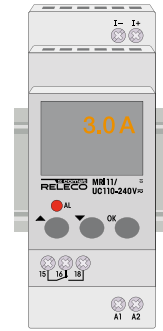
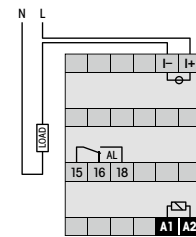
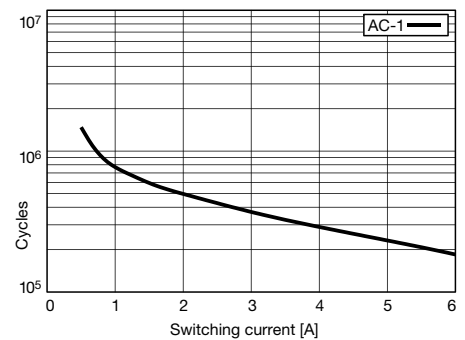
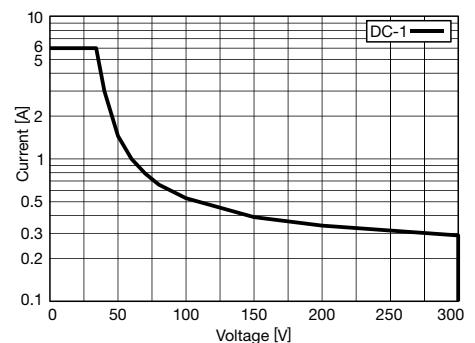
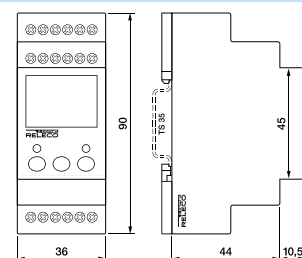
Connection diagram

Fig.1 AC voltage endurance

Fig. 2 DC load limit curve

Dimensions [mm]

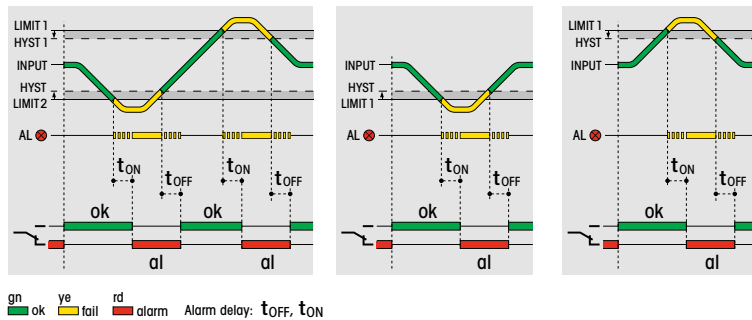
Technical approvals, conformities

Type: MRI32/...V

Current monitoring relay with over- and under current thresholds up to 5 A. Alarm delay setting. Alarm LED. Display for voltmeter function, alarm signal and interactive parameter setting. 2 change-over alarm contacts 5 A 250 V. Comfortable parameter setting.

Monitoring function



Measuring circuit data

Over/under current setting ranges AC / DC	0 ... 5 A
Frequency	DC, AC 16 ... 100 Hz
Resolution	1 mA
Accuracy	2 % ± 1 digit
Input resistance	5 MΩ

Time data

Alarm delay setting time	0.1 ... 999.9 s
Reset time setting range	0.1 ... 999.9 s
Voltage failure buffering	ca. 30 ms

Contacts

Type / Material	2 CO / AgNi 0.15
Rated operational current	6 A
Max. inrush current	15 A
Max. switching voltage	250 V
Max. AC load AC-1 (Fig.1)	1250 VA
Max. DC load DC-1, 24 V / 220 V (Fig.2)	120 W / 25 W
Recommended min. contact load	10 mA / 10 V

Power supply

	UC12-48V	UC110-240V
Nominal voltage AC/DC	12 ... 48 V	110 ... 240 V
Operating voltage range	9.6 ... 57.6 V	88 ... 288 V
AC frequency	16 ... 63 Hz	16 ... 63 Hz
Power consumption	2 W / 4 VA	2 W / 4 VA

Insulation

Test voltage open - contact	1 kVrms 1 minute
Test voltage between poles	2.5 kVrms 1 minute
Test voltage measuring input - contacts	4 kVrms 1 minute
Test voltage measuring input - power supply	4 kVrms 1 minute

General specifications

Ambient temperature storage /operation	-40 ... +85 °C / -25 ... +60 °C
Mechanical life of contacts	30 x 10 ⁶ operations
Conductor cross section	Stranded wire 2.5 mm ² , 2 x 1.5 mm ²
Ingress protection degree	IP20, (electronics: IP40)
Max. screw torque	0.4 Nm
Housing material	Lexan EXL 9330
Weight	130 g

Standard types

AC/DC 12-48 V, 15...60 Hz
AC/DC 110-240 V, 15...60 Hz

MRI32/UC12-48V
MRI32/UC110-240V

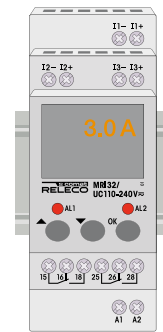

Connection diagram

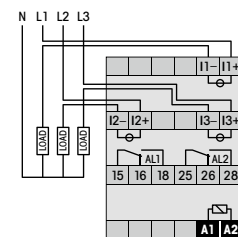

Fig.1 AC voltage endurance

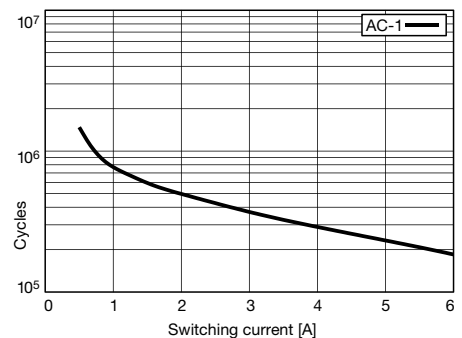
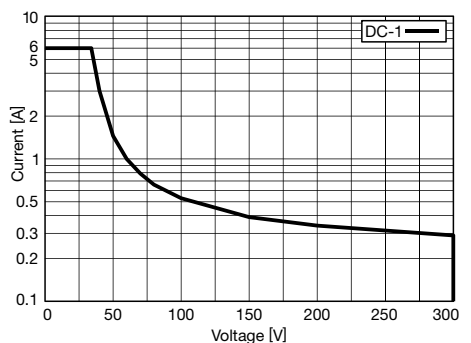
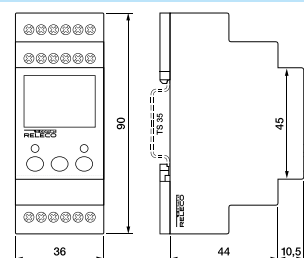

Fig. 2 DC load limit curve



Dimensions [mm]



Technical approvals, conformities



Type: MRM11/...V

Multifunctional monitoring relay for simultaneous measurement of current and voltage and monitoring of U, I, P, cos φ and f. Alarm delay setting. Alarm LED. Display for multimeter function, alarm signal and interactive parameter setting.
 1 change-over alarm contact 5 A 250 V. Comfortable parameter setting.

Monitoring function

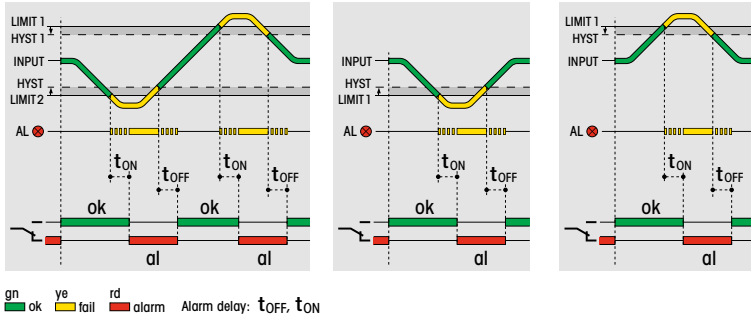

Measuring circuit data

Voltage setting ranges AC / DC	0 ... 480 V / 0 ... 700 V
Current setting ranges AC / DC	0 ... 5 A
Frequency	DC, AC 16 ... 100 Hz
Resolution U / I	100 mV / 1 mA
Accuracy	2 % ± 1 digit
Input resistance U / I	1 MΩ / 5 MΩ

Time data

Alarm delay setting time	0.1 ... 999.9 s
Reset time setting range	0.1 ... 999.9 s
Voltage failure buffering	ca. 30 ms

Contacts

Type / Material	1 CO / AgNi 0.15
Rated operational current	6 A
Max. inrush current	15 A
Max. switching voltage	250 V
Max. AC load AC-1 (Fig.1)	1250 VA
Max. DC load DC-1, 24 V / 220 V (Fig.2)	120 W / 25 V
Recommended min. contact load	10 mA / 10 V

Power supply

	UC12-48V	UC110-240V
Nominal voltage AC/DC	12 ... 48 V	110 ... 240 V
Operating voltage range	9.6 ... 57.6 V	88 ... 288 V
AC frequency	16 ... 63 Hz	16 ... 63 Hz
Power consumption	2 W / 4 VA	2 W / 4 VA

Insulation

Test voltage open - contact	1 kVrms 1 minute
Test voltage measuring input - contacts	4 kVrms 1 minute
Test voltage measuring input - power supply	4 kVrms 1 minute

General specifications

Ambient temperature storage /operation	-40 ... +85 °C / -25 ... +60 °C
Mechanical life of contacts	30 x 10 ⁶ operations
Conductor cross section	Stranded wire 2.5 mm ² , 2 x 1.5 mm ²
Ingress protection degree	IP20, (electronics: IP40)
Max. screw torque	0.4 Nm
Housing material	Lexan EXL 9330
Weight	130 g

Standard types

AC/DC 12-48 V, 15...60 Hz
AC/DC 110-240 V, 15...60 Hz

MRM11/UC12-48V
MRM11/UC110-240V

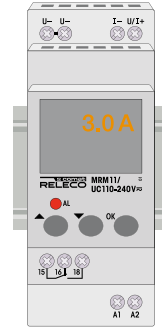

Connection diagram

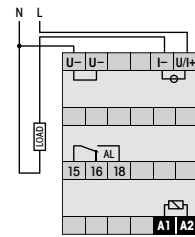

Fig.1 AC voltage endurance

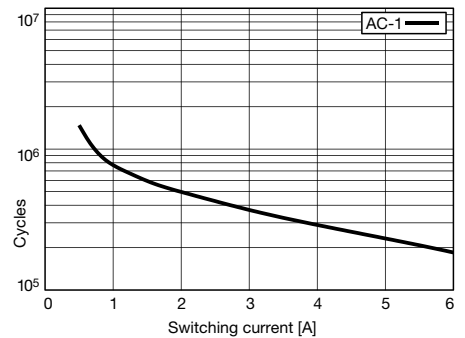
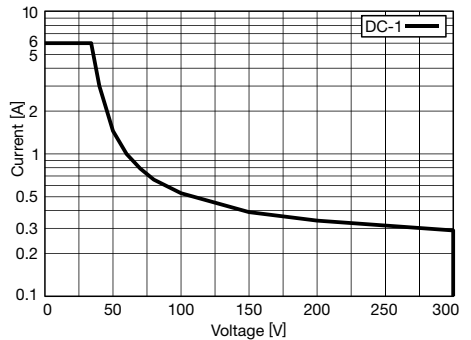
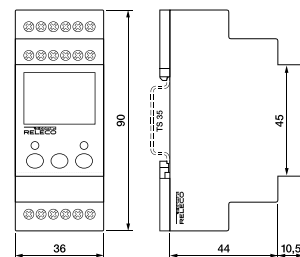

Fig. 2 DC load limit curve



Dimensions [mm]



Technical approvals, conformities



MRM32

Multifunction monitoring relay AC/DC, three phase DIN Rail mounting according to DIN 43 880

Type: MRM32/...V

Multifunctional monitoring relay for simultaneous measurement of current and voltage and monitoring of U, I, P, cosφ and f and Δφ. Alarm delay setting. Alarm LED. Display for multimeter function, alarm signal and interactive parameter setting.

2 change-over alarm contacts 5 A 250 V. Comfortable parameter setting.

Monitoring function

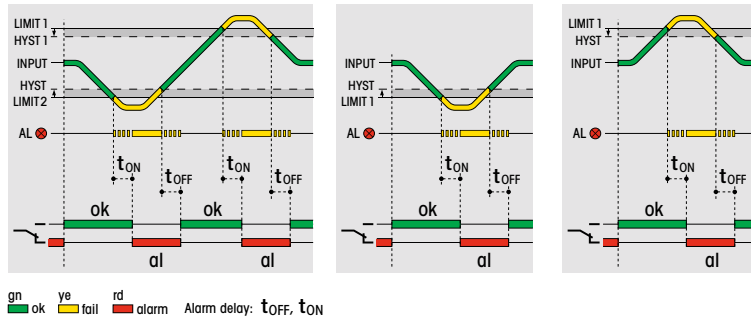

Measuring circuit data

Voltage setting ranges AC / DC	0 ... 480 V / 0 ... 700 V
Current setting ranges AC / DC	0 ... 5 A
Frequency	DC, AC 16 ... 100 Hz
Resolution U / I	100 mV / 1 mA
Accuracy	2 % ± 1 digit
Input resistance U / I	1 MΩ / 5 MΩ

Time data

Alarm delay setting time	0.1 ... 999.9 s
Reset time setting range	0.1 ... 999.9 s
Voltage failure buffering	ca. 30 ms

Contacts

Type / Material	2 CO / AgNi 0.15
Rated operational current	6 A
Max. inrush current	15 A
Max. switching voltage	250 V
Max. AC load AC-1 (Fig.1)	1250 VA
Max. DC load DC-1, 24 V / 220 V (Fig.2)	120 W / 25 W
Recommended min. contact load	10 mA / 10 V

Power supply

	UC12-48V	UC110-240V
Nominal voltage AC/DC	12 ... 48 V	110 ... 240 V
Operating voltage range	9.6 ... 57.6 V	88 ... 288 V
AC frequency	16 ... 63 Hz	16 ... 63 Hz
Power consumption	2 W / 4 VA	2 W / 4 VA

Insulation

Test voltage open - contact	1 kVrms 1 minute
Test voltage between poles	2.5 kVrms 1 minute
Test voltage measuring input - contacts	4 kVrms 1 minute
Test voltage measuring input - power supply	4 kVrms 1 minute

General specifications

Ambient temperature storage /operation	-40 ... +85 °C / -25 ... +60 °C
Mechanical life of contacts	30 x 10 ⁶ operations
Conductor cross section	Stranded wire 2.5 mm ² , 2 x 1.5 mm ²
Ingress protection degree	IP20, (electronics: IP40)
Max. screw torque	0.4 Nm
Housing material	Lexan EXL 9330
Weight	130 g

Standard types

AC/DC 12-48 V, 15...60 Hz
AC/DC 110-240 V, 15...60 Hz

MRM32/UC12-48V
MRM32/UC110-240V

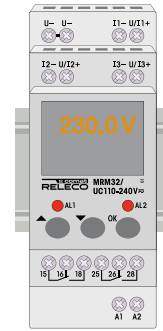

Connection diagram

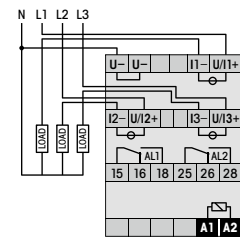

Fig.1 AC voltage endurance

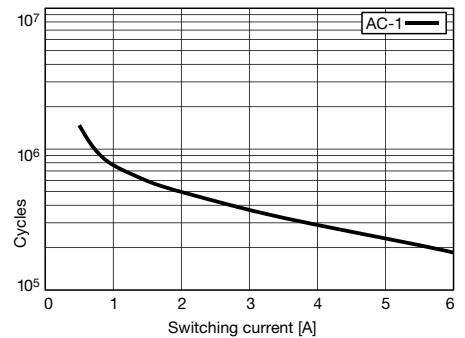
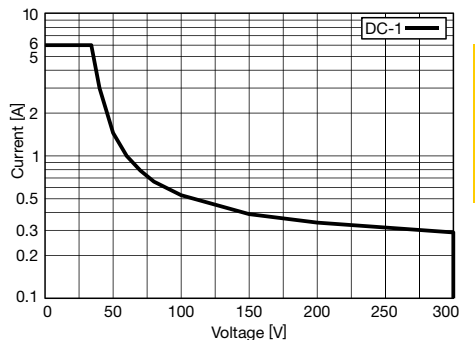
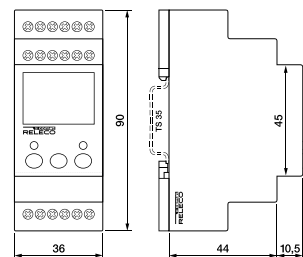

Fig. 2 DC load limit curve



Dimensions [mm]



Technical approvals, conformities



Type: MV53 /... V

Voltage monitoring relay with over- and under voltage thresholds. Adjustable alarm delay. Alarm LED. Threshold setting by DIP switch. 1 change over alarm contact 6 A 250 V. Very suitable for protecting of contactor coils against under voltage (under voltage → low Z of coil → over current → defective).

Monitoring function

Threshold settings in % of nominal voltage. Do not set 0 % for both thresholds.

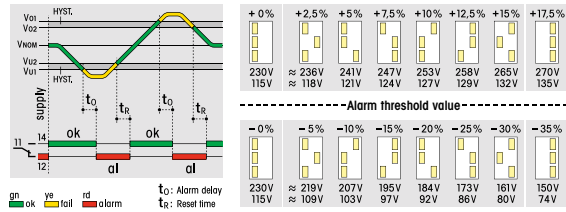

Measuring circuit data

Nominal voltage V_{nom} , type	AC 115 V / AC 230 V
Over voltage setting range (2.5 % steps)	0 ... 17.5 % from V_{nom}
Under voltage setting range (5 % steps)	0 ... - 35 % from V_{nom}
Frequency range	45 ... 65 Hz
Accuracy	± 3 %

Time data

Fault detection time	100 ms
Alarm delay adjustment range	25 ms ... 2.5 s
Voltage failure buffering	≥ 10 ms

Contacts

Type / Material	1 CO, micro disconnection / AgNi
Rated operational current	6 A
Max. inrush current (10 ms)	15 A
Max. switching voltage	250 V
Max. AC load AC-1 (Fig.1)	1500 VA
Max. DC load DC-1, 24 V / 220 V (Fig.2)	120 W / 65 W
Recommended min. contact load	100 mA / 5 V

Power supply

	AC 115 V	AC 230 V
Nominal voltage		
Operating voltage range	65 ... 135 V	130 ... 270 V
Power consumption	2.2 W	2.2 W
Frequency range	45 ... 65 Hz	45 ... 65 Hz
Surge immunity EN 6100-4-5	2 kV	2 kV

Insulation

Test voltage open contact	1 kVrms 1 minute
Test voltage between contact and power supply	2 kVrms 1 minute

General specifications

Ambient temperature storage /operation	-40 ... +85 °C / -25 ... +60 °C
Mechanical life of contacts	20 x 10 ⁶ operations
Conductor cross section	Stranded wire 2.5 mm ² , 2 x 1.5 mm ²
Ingress protection degree	Housing: IP 40, terminals: IP 20
Max. Screw torque	0.4 Nm
Housing material	Lexan
Weight	80 g

Standard types

AC 115 50 / 60 Hz	MV53/AC115V
AC 230 50 / 60 Hz	MV53/AC230V

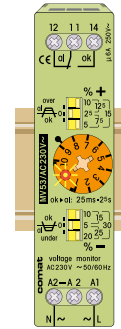

Connection diagram

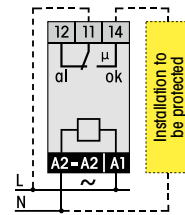

Fig.1 Contact endurance

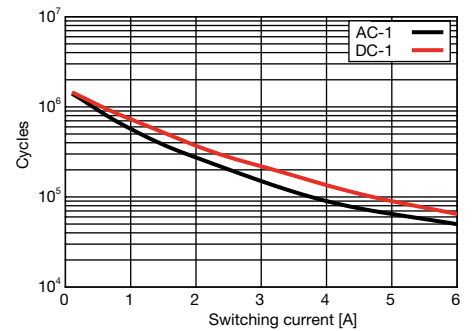
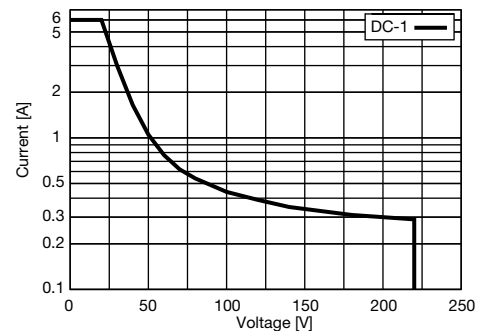
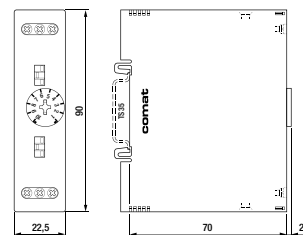

Fig. 2 DC load limit curve



Dimensions [mm]



Technical approvals, conformities



EOCR, EUCR

Current monitoring relay with 2 current inputs DIN Rail mounting according to DIN 43 880



Type: EOCR-AR-... / ... V (Over current), EUCR-BR-... / ... V (Under current)

AC current monitoring relay for 1 or 3 phase lines, 1 change over alarm contact 3 A / 250 V
Integrated current transformer coupling system, 6 A, 30 A, 60 A types

Monitoring function

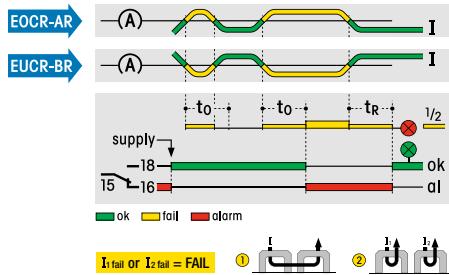

The EOCR-AR and the EUCR-BR monitor overcurrent and undercurrent on AC power circuits. One or two current paths can be monitored directly up to 60 (75) A, by means of the integrated current loop transformers. The adjustable alarm delay (t_0) and the automatic alarm resetting (t_R) permit universal usage in motor and transformer protection systems, monitoring of electrical heating elements and in the control of pumps, ventilation systems, suction and feed devices.

Measuring circuit data

Setting ranges	0.5 ... 6 A / 3 ... 30 A / 5 ... 60 A
Frequency range	48 ... 62 Hz
Accuracy	2.5 %
Hysteresis	3 % from set value
Max. continuous current 6 / 30 / 60 A type	60 A / 90 A / 120 A
Peak current (1 sec) 6 / 30 / 60 A type	3 kA / 5 kA / 5 kA

1) Expansion of the current ranges:
Lower currents (see table at right):
Higher currents:

Two or more loops through the current transformer.
External current transformer. See accessories.

Time data

Alarm delay time adjustment range	0.3 ... 30 s
Reset time adjustment range	0.5 ... 150 s
Response time, power on, on A1	80 ... 150 ms

Contacts

Type / Material	1 CO, micro disconnection / AgNi
Rated operational current	3 A
Max. switching voltage, AC-1	250 V
Max. AC load	750 VA
Max. DC load	90 W

Power supply

	UC 24 V	AC 115 V	AC 230 V
Nominal voltage (UC = AC/DC)			
Operation voltage range [V]	19 ... 30	88 ... 130	184 ... 264
Power consumption [W]	1.5	1.5	1.5
Frequency [Hz]	50 / 60	50 / 60	50 / 60

Insulation

Test voltage between contacts and supply inp.	2 kVrms 1 minute
Test voltage between curr. transf. and other circuits	4 kVrms 1 minute

General specifications

Ambient temperature storage /operation	-25 ... 85 °C / -20 ... 60 °C
Ingress protection degree	Housing: IP 40, terminals: IP 20
Max. screw torque	0.8 Nm
Weight	120 g

Standard types

Current [x] 05/30/60

Over current	Under current
EOCR-AR- x /UC24V	EUCR-BR-x /UC24V
EOCR-AR- x /AC115V	EUCR-BR-x /AC115V
EOCR-AR- x /AC230V	EUCR-BR-x /AC230V

Accessories

Current transformer for expanded current values, 50, 100, 250, 500 A **SRCT-35-.../5A**

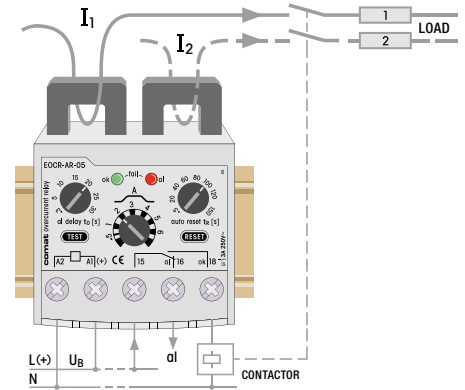

Connection diagram

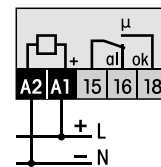

Expansion of current ranges

[A]	1x	2x	3x	4x	5x
-05	0,5-6	0,25-3	0,17-2	0,13-1,5	0,1-1,2
-30	2,5-30	1,25-15	0,83-10	0,62-7,5	0,5-6
-60	5-60	2,5-30	1,7-20	1,25-15	1-12

Dimensions [mm]

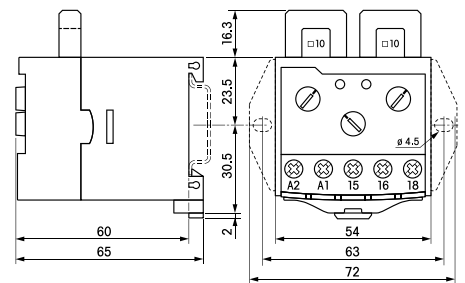

Monitoring Relays 3.2

3

Technical approvals, conformities



Type: SSU34/... V

Monitoring relay for under / over voltage, phase sequence, phase loss, phase angle, frequency, asymmetry. Star or delta operation. 2 change over alarm contacts 6 A 250V

Monitoring function

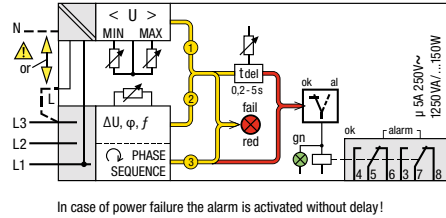

In case of power failure the alarm is activated without delay!

The SSU34 (50Hz) provide comprehensive monitoring of three-phase mains supplies with or without neutral.

The following mains faults are monitored:

Error signal ① U (V_{Δ} , V_{λ}):

Exceeding or dropping below the set voltage values U_{min}/U_{max} for L1-N or L1-L3,L (no differential voltage, phase position or frequency fault).

Error signal ② ΔU , $\Delta \phi$, Δf :

One or more of the three voltages, phase positions, or the mains frequency are diverging from the required value. Depending on the nature of their occurrence Δ -errors are evaluated cumulatively.

Error signal ③:

Connection polarity reversal (wrong phase-sequence). Any error is signalled by the red LED "fail" and is reported after expiry of the set alarm-delay time (for error signal ③ undelayed) via 5-6 and 7-8.

In the correct status (ok) the green LED is illuminated (5-6 and 7-8 open, 5-4 and 7-3 closed).

Measuring circuit data

Nominal mains voltage	100 V	400 V	500 V
Under voltage adj. range [V] ¹⁾	40 ... 55	160 ... 225	200 ... 280
Over voltage adj. range [V] ¹⁾	61 ... 70	235 ... 275	300 ... 350
Δ voltage adj. range [V] ²⁾	5 ... 25	20 ... 100	20 ... 100
$\Delta\phi$ adjustment range [°] ²⁾	3 ... 15	3 ... 15	3 ... 15
Δf adjustment range [Hz] ²⁾	3 ... 15	3 ... 15	3 ... 15

¹⁾ L - N ²⁾ adjustment with the same rotary knob

Time data

Alarm delay adjustment range	0.2 ... 5 s
Reset time	100 ... 400 ms

Contacts

Type / material	2 CO, micro disconnection / AgNi
Rated operational current	5 A
Max. inrush current (20 ms)	15 A
Max. AC switching voltage AC-1	250 V
Max. AC load AC-1 (Fig.1)	1250 VA
Max. DC load 30 V / 250 V DC-1	150 W / 60 W
Recommended min. contact load	10 mA / 12 V

Power supply data

Nominal mains voltage	100 V	400 V	500 V
Operating voltage range [V] ¹⁾	35 ... 70	140 ... 285	180 ... 360
Power consumption [W]	≤ 1.5	≤ 1.5	≤ 1.5
Input current [mA]	150	30	25
Frequency [Hz]	50	50	50

Insulation

Test voltage between contacts and supply	3 kVrms 1 minute (basic insulation)
--	-------------------------------------

General specifications

Ambient temperature storage /operation	-40 ... +85 °C/-10 ... +60 °C
Mechanical life of contacts	30 x 10 ⁶ operations
Ingress protection degree	Housing: IP 40, terminals: IP 20
Max. screw torque	0.5 Nm
Housing material / Weight	Lexan / 350 g

Standard types

50 Hz, AC 100, 400, 500

"..." enter the voltage for full type designation

SSU34/AC...V

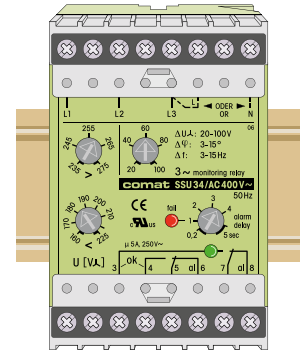

Connection diagram

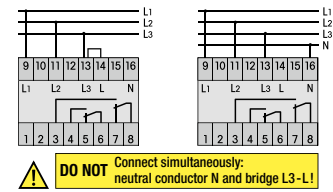

Fig. 1 AC electrical endurance

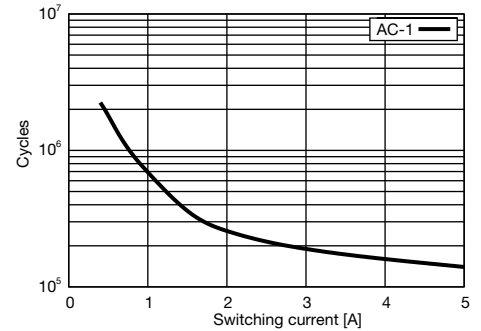
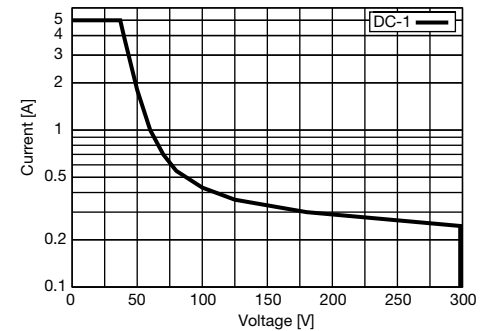
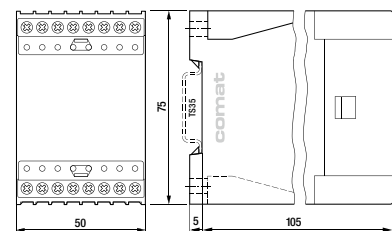

Fig. 2 DC load limit curve



Dimensions [mm]



Technical approvals, conformities

EN 60947



Type: SSU36/... V

Monitoring relay for under / over voltage, phase sequence, phase loss, phase angle, frequency, asymmetry. Star or delta operation. 2 change over alarm contacts 6 A 250V

Monitoring function

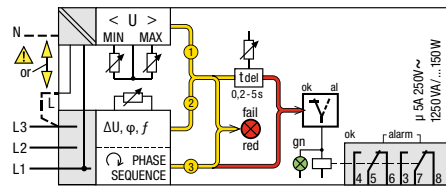

In case of power failure the alarm is activated without delay!

The SSU36 (60Hz) provide comprehensive monitoring of three-phase mains supplies with or without neutral.

The following mains faults are monitored:

Error signal \odot U (Δ , ∇):

Exceeding or dropping below the set voltage values Umin/Umax for L1-N or L1-L3,L (no differential voltage, phase position or frequency fault).

Error signal \odot Δ U, Δ ϕ , Δ f:

One or more of the three voltages, phase positions, or the mains frequency are diverging from the required value. Depending on the nature of their occurrence Δ -errors are evaluated cumulatively.

Error signal \odot :

Connection polarity reversal (wrong phase-sequence). Any error is signalled by the red LED "fail" and is reported after expiry of the set alarm-delay time (for error signal \odot undelayed) via 5-6 and 7-8.

In the correct status (ok) the green LED is illuminated (5-6 and 7-8 open, 5-4 and 7-3 closed).

Measuring circuit data

Nominal mains voltage	208 V	460 V	480 V
Under voltage adj. range [V] ¹⁾	85 ... 115	186 ... 260	194 ... 270
Over voltage adj. range [V] ¹⁾	125 ... 145	270 ... 318	284 ... 332
Δ voltage adj. range [V] ^{1) 2)}	10 ... 50	20 ... 100	20 ... 100
Δ ϕ adjustment range [°] ²⁾	5 ... 24	4 ... 21	4 ... 21
Δ f adjustment range [Hz] ²⁾	3 ... 22	3 ... 19	3 ... 19

¹⁾ L - N ²⁾ adjustment with the same rotary knob

Time data

Alarm delay adjustment range	0.2 ... 5 s
Reset time	100 ... 400 ms

Contacts

Type / material	2 CO, micro disconnection / AgNi
Rated operational current	5 A
Max. inrush current (20 ms)	15 A
Max. AC switching voltage AC-1	250 V
Max. AC load AC-1 (Fig.1)	1250 VA
Max. DC load 30 V / 250 V DC-1	150 W / 60 W
Recommended min. contact load	10 mA / 12 V

Power supply data

Nominal mains voltage	208 V	460 V	480 V
Operating voltage range [V] ¹⁾	75 ... 150	160 ... 331	170 ... 346
Power consumption [W]	\leq 1.5	\leq 1.5	\leq 1.5
Input current [mA]	70	25	25
Frequency [Hz]	60	60	60

Insulation

Test voltage between contacts and supply	3 kVrms 1 minute (basic insulation)
--	-------------------------------------

General specifications

Ambient temperature storage /operation	-40 ... +85 °C / -10 ...+60 °C
Mechanical life of contacts	30 x 10 ⁶ operations
Ingress protection degree	Housing: IP 40, terminals: IP 20
Max. screw torque	0.5 Nm
Housing material / Weight	Lexan / 350 g

Standard types

60 Hz , AC 208, 460, 480

SSU36/AC...V

"..." enter the voltage for full type designation

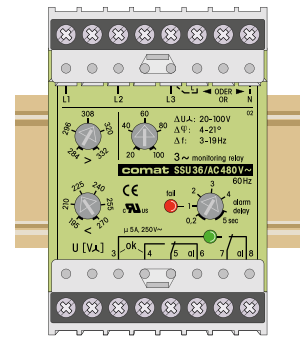

Connection diagram

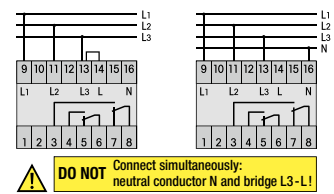

Fig. 1 AC electrical endurance

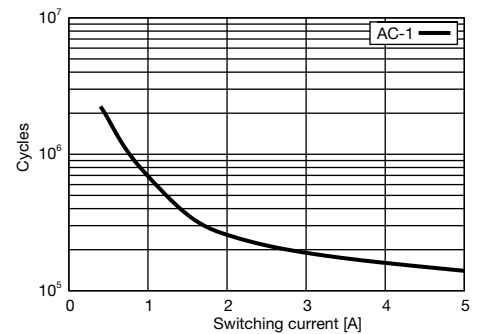
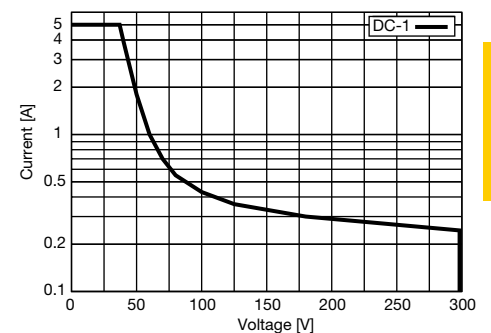
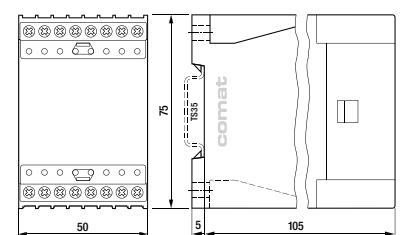

Fig. 2 DC load limit curve



Dimensions [mm]



Technical approvals, conformities



ESU-D2

Insulation monitoring relay for unearthed DC-networks DIN Rail mounting according to DIN 43 880



Type: ESU-D2/... V

Earth insulation resistance monitoring relay
Pre alarm 1 CO and main alarm 1 NO + 1 CO contact outputs 5 A / 250 V
UC 24 ... 48 V, UC 110 ... 240 V operating voltages, monitoring of
DC 12 ... 48 V power supply networks. Monitoring of earth interruption on the device.
The device measures single or combined resistances occurring against + or - pole of the
DC network. Adjustable alarm delay. Proved reliability in rolling stock applications.

Monitoring function

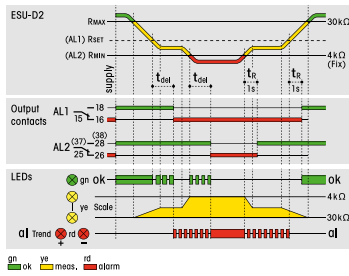

The ESU-D2 monitors the isolation resistance in non-grounded DC-networks (24 – 48 V).
Two alarm steps (prealarm AL1 and main alarm AL2) are indicated via separate output contacts.
Displays: bargraph-display of the measured earthing resistance (green = ok). Two red LEDs show the ground tendency towards plus (+) or minus (-).
Output terminals 5 V for the external display of the earthing resistance (0,1 V/kΩ).
Test functions: Periodic automatic check, also with key "Test".
Environmental failures: monitoring of AC-short circuit, over-voltage, ground interruption.

Measuring circuit data

Measuring / setting range for pre alarm	1 ... 50 kΩ / 4 ... 30 kΩ
Constant value for main alarm	4 kΩ
Tolerance	≤ 10 %
Overvoltage alarm level of DC network	60 V
Input current + → -	≤ 5 mA
Sampling current pulses +/- → earth	0.2 mA
Overvoltage safety from earth to +/- poles	AC 250 V
Max. capacity +/- → earth	1.5 μF ¹⁾

¹⁾ Types for capacitances until 60 μF on request

Time data

Alarm delay time adjustment range	0.1 ... 10 s
Fault detection time	800 ms
Auto reset time, fail to OK	1 s

Contacts

Type / Material	2 CO, 1 NO micro disconnection / AgNi
Rated operational current / min. contact load	5 A / 1 mA 12 V
Max. switching voltage (Fig. 1)	250 V

Power supply

	UC 24-48 V	UC 110 – 240 V
Nominal voltage	18 ... 60 V	88 ... 265 V
Operation voltage range	2 W	2 W
Power consumption	≥ 50 ms	≥ 50 ms
Voltage failure buffering		

Insulation

Test voltage contacts to other circuits	2 kVrms 1 minute
---	------------------

General specifications

Ambient temperature storage /operation	-40 ... 85 °C / -10 ... 60 °C
Ingress protection degree	Housing: IP 40, terminals: IP 20
Max. screw torque	0.5 Nm
Weight	250 g

Standard types

UC 110-240	ESU-D2/UC110-240V
UC24-48	ESU-D2/UC24-48V

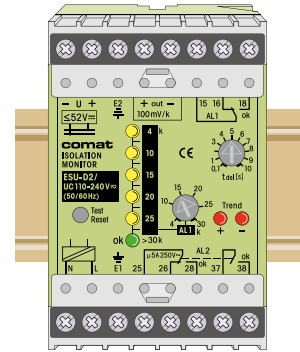

Connection diagram

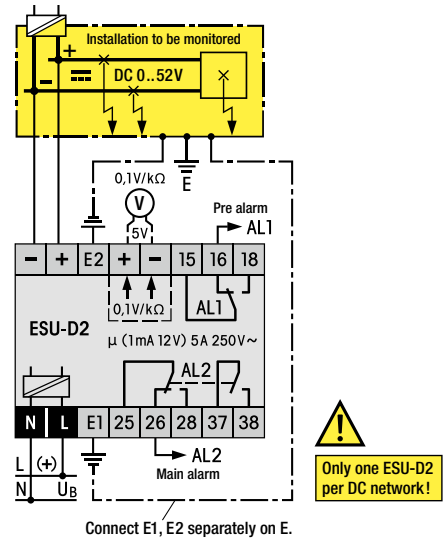
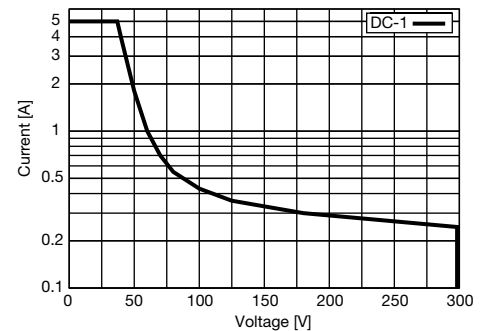
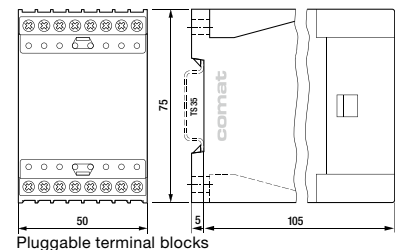

Fig. 1 DC load limit curve



Dimensions [mm]



Technical approvals, conformities

EN 60947

